

Quantum effects in Graphene Condensed Matter meets Relativistic Quantum Field Theory

Roberto Soldati

Dipartimento di Fisica

Università di Bologna

Sestri Levante 8 June 2009

Collaboration with

Carlota Gabriela Beneventano

Eve Mariel Santangelo

Universidad Nacional de La Plata (Argentina)

Paola Giacconi

I.N.F.N. Sezione di Bologna (Italia)

Abstract : the relationship between the tight-binding Hamiltonian of the two-dimensional honeycomb lattice of carbon atoms (graphene) with nearest neighbour hopping and the Hamiltonian of planar quantum electrodynamics QED_{2+1} for massless spinors is briefly reviewed. The remarkable and observable 1-loop quantum effects due to the presence of constant and homogeneous electric and magnetic field are discussed both at zero and finite temperature and density. The Hall conductivity and the minimum quantum conductivity, as predicted by canonical quantum field theory, turn out to be perfectly consistent with the measured values for graphene

C.G.Beneventano, P.Giacconi, E.M.Santangelo, R.S.
*The Quantum Hall Effect in Graphene Samples and
the Relativistic Dirac Effective Action*

J. Phys. Math. Theor. **A40**, F435-F442 (2007)

*Planar QED at Finite Temperature and Density: Hall
Conductivity, Berry's Phases and Minimal
Conductivity of Graphene*, *ibid.* in the press (2009)

Contents

⇒ ●	Graphene : Electrons in Flatland	1
●	Effective Model	4
●	Magnetic field at $T = 0 = \mu$.	8
●	Effective Action at $T \neq 0 \neq \mu$	11
●	Hall Current Density	19
●	Large Gauge Transformations	21
●	Electric field at $T = 0 = \mu$. .	24
●	Effective Action and Pairs . .	35
●	Conclusions	38

Graphene : Electrons in Flatland

Truly 2-dimensional Carbon : Unique Electronic Properties

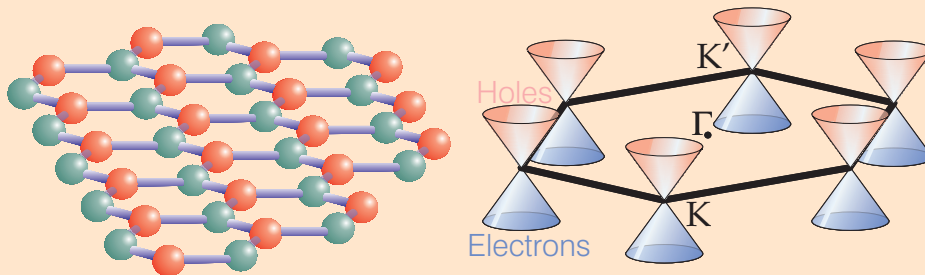

mono- and bi-layer samples recently obtained in laboratory

- K.S. Novoselov, A.K. Geim, S.V. Morozov, D. Jiang, M.I. Katsnelson, I.V. Grigorieva, S.V. Dubonos and A.A. Firsov, *Nature* **438**, 197 (2005)
- Y. Zhang, Y-W. Tang, H.L. Stormer, P. Kim, *Nature* **438**, 201 (2005)
- K.S. Novoselov, E. McCann, S.V. Morozov, V.I. Falko, M.I. Katsnelson, U. Zeitler, D. Jiang, F. Schedin, A.K. Geim, *Nature Physics* **2**, 177-180 (2006)

Unexpected behaviour of the Hall Conductivity
for mono-layer and bi-layer Graphene samples

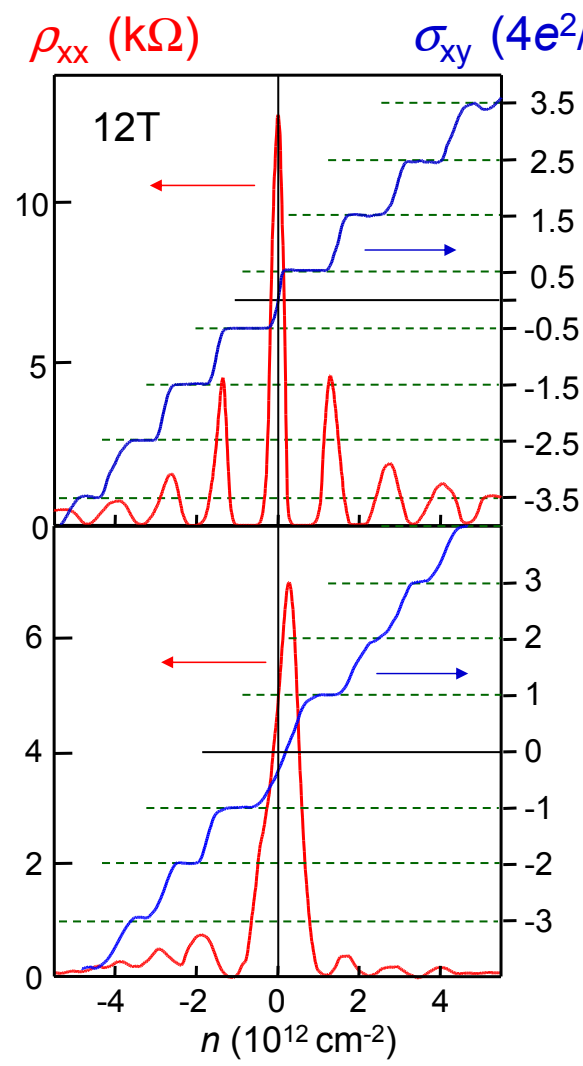

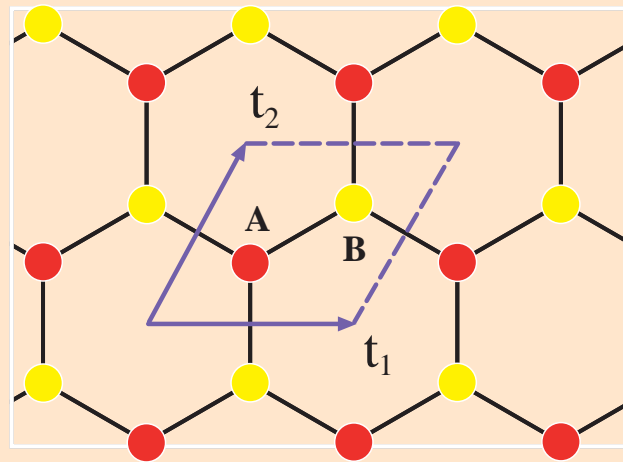

EFFECTIVE THEORY FOR CHARGE CARRIERS
 quasiparticles (electrons) and quasiantiparticles (holes)
 MASSLESS Dirac field in $2+1$ dimensions
 reducible Clifford representation and two *flavours*

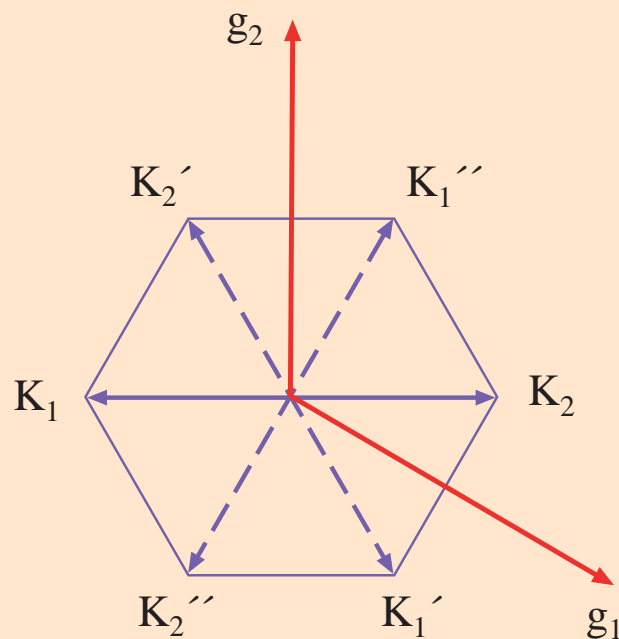

Reciprocal Lattice (g_1 and g_2 rhombic sites)

Effective Model

Gusynin-Sharapov-Carbotte : *Int.J.Mod.Phys. B21* (2007)

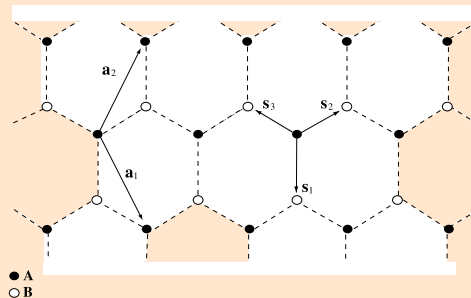

any A atom at position $\mathbf{n} = \mathbf{a}_1 n_1 + \mathbf{a}_2 n_2$ (n_1 and n_2 integers) is connected to its nearest neighbours on B sites by the three vectors

$$\boldsymbol{\delta}_1 = \frac{1}{3}\mathbf{a}_1 - \frac{1}{3}\mathbf{a}_2 \quad \boldsymbol{\delta}_2 = \frac{1}{3}\mathbf{a}_1 + \frac{2}{3}\mathbf{a}_2 \quad \boldsymbol{\delta}_3 = -\boldsymbol{\delta}_1 - \boldsymbol{\delta}_2$$

we start with the simplest tight-binding description for carbon orbitals in terms of the Hamiltonian operator

$$H = -\varepsilon \sum_{\mathbf{n}, \boldsymbol{\delta}, \sigma} a_{\mathbf{n}, \sigma}^\dagger b_{\mathbf{n} + \boldsymbol{\delta}, \sigma} + \text{h.c.}$$

where the anticommuting Fermi operators

$$a_{\mathbf{n}, \sigma} \quad b_{\mathbf{n} + \boldsymbol{\delta}, \sigma}$$

act for electrons with spin $\sigma = \uparrow, \downarrow$

In the momentum representation the Hamiltonian reads

$$H = \sum_{\sigma} \int_{BZ} \frac{d^2k}{(2\pi)^2} \mathbf{r}_{\sigma}^{\dagger}(\mathbf{k}) [\mathcal{H}(\mathbf{k}) - \mu] \mathbf{r}_{\sigma}(\mathbf{k})$$

where the integration runs over the extended rhombic Brillouin Zone while I have introduced the spinors

$$\mathbf{r}_{\sigma}(\mathbf{k}) = \begin{pmatrix} a_{\sigma}(\mathbf{k}) \\ b_{\sigma}(\mathbf{k}) \end{pmatrix}$$

together with the off-diagonal matrix

$$\mathcal{H}(\mathbf{k}) = \begin{pmatrix} 0 & \phi(\mathbf{k}) \\ \phi^*(\mathbf{k}) & 0 \end{pmatrix}$$

$$\phi(\mathbf{k}) = -\varepsilon \sum_{\delta} \exp\{i \mathbf{k} \cdot \delta\} \equiv -E(\mathbf{k}) \exp\{i \varphi(\mathbf{k})\}$$

and additional term with the chemical potential $\mu \in \mathbf{R}$

QED₂₊₁ description of graphene

graphene contains 2 atoms per unit cell [**2 flavours**]

the spectrum of quasiparticles excitations has 2 branches [**2 bands**]

with dispersion relations $E_{\pm}(\mathbf{k}) = \pm E(\mathbf{k})$

$$E(\mathbf{k}) = \varepsilon \sqrt{1 + 4 \cos \frac{1}{2} k_x a \left(\cos \frac{1}{2} k_x a + \cos \frac{\sqrt{3}}{2} k_y a \right)}$$

$$a = |\mathbf{a}_1| = |\mathbf{a}_2|$$

$\mathcal{H}(\mathbf{k})$ vanishes at the 6 corners of the hexagonal Brillouin Zone

but **only 2 are inequivalent** for example

$$\mathbf{k}_{\pm} = \pm \left(\frac{4\pi}{3a\sqrt{3}}, 0 \right) \quad \phi(\mathbf{k}_{\pm}) = 0$$

Expanding around them as

$$\phi(\mathbf{k}_{\pm} + \mathbf{p}) = \pm \hbar v_F (p_x \mp ip_y)$$

where $v_F = \varepsilon a \sqrt{3} / 2 \hbar \approx 10^6$ m/s is the **Fermi velocity** we eventually obtain the Hamiltonian densities

$$\mathcal{H}(\mathbf{k}_{\pm} + \mathbf{p}) \equiv \mathcal{H}_{\pm}(\mathbf{p}) = \hbar v_F (\pm \sigma_1 p_x + \sigma_2 p_y)$$

D.P. DiVincenzo and E.J. Mele, Phys. Rev. B **29** (1984) 1685

G.W. Semenoff, Phys. Rev. Lett. **53** (1984) 2449

I use two 2-component spinors at the \mathbf{k}_\pm points

$$\Upsilon_\sigma(\mathbf{k}_+ + \mathbf{p}) \equiv \psi_\sigma(\mathbf{p}) = \begin{pmatrix} a_\sigma(\mathbf{p}) \\ b_\sigma(\mathbf{p}) \end{pmatrix}$$

$$\Upsilon_\sigma(\mathbf{k}_- + \mathbf{p}) \equiv \tilde{\psi}_\sigma(\mathbf{p}) = \begin{pmatrix} \tilde{a}_\sigma(\mathbf{p}) \\ \tilde{b}_\sigma(\mathbf{p}) \end{pmatrix}$$

two 2-dimensional Hamiltonians for the two inequivalent Irreducible Clifford Representations τ and $\tilde{\tau}$

$$H_+ = \sum_\sigma \int_{DC} \frac{d^2p}{(2\pi)^2} \psi_\sigma^\dagger(\mathbf{p}) [\mathcal{H}_+(\mathbf{p}) - \mu] \psi_\sigma(\mathbf{p})$$

$$H_- = \sum_\sigma \int_{DC} \frac{d^2p}{(2\pi)^2} \tilde{\psi}_\sigma^\dagger(\mathbf{p}) [\mathcal{H}_-(\mathbf{p}) - \mu] \tilde{\psi}_\sigma(\mathbf{p})$$

the Dirac Cone *DC* is specified by the energy cutoff

$$w = \hbar v_F \sqrt{\frac{\mathcal{B}}{2\pi}} = \frac{\hbar v_F}{a} \sqrt{\frac{4\pi}{\sqrt{3}}} = \varepsilon \sqrt{\pi\sqrt{3}} \approx 2.33 \varepsilon$$

$$\mathcal{A} = \frac{\sqrt{3}}{2} a^2 \text{ unit cell area} \quad \mathcal{B} = (2\pi)^2 / \mathcal{A} \text{ BZ area}^{-1}$$

Magnetic field at $T = 0 = \mu$

Natural units ($\hbar = c = v_F = k_B = 1$)

Massless Dirac fields in the Oxy -plane for
1 flavour and 1 irreducible Clifford representation

Uniform magnetic field $B > 0$ and charge $-e < 0$

Landau asymmetric gauge

$$eA_\nu = (0, 0, eBx) \quad \text{with} \quad B > 0$$

$$\gamma^0 = \sigma_3 \quad \gamma^j = i\sigma_j \quad j = 1, 2$$

From Dirac equation and the stationary ansatz

$$(i\partial + eA)\Psi(t, x, y) = 0 \quad \Psi(t, x, y) = e^{-iEt} \psi_E(x, y)$$

Spectral resolution of the self-adjoint Dirac Hamiltonian

$$H\psi_E = [i\partial_x\sigma_2 - (i\partial_y + eBx)\sigma_1] \psi_E(x, y) = 0$$

$$\psi_E(x, y) = \frac{1}{\sqrt{(2\pi)}} \int_{-\infty}^{\infty} dp_y \psi_{E, p_y}(x) e^{iy p_y}$$

The lowest Landau band

Dimensionless coordinates

$$b = \text{sgn}(p_y) \sqrt{\frac{2p_y^2}{eB}} \quad (\text{Landau band coordinate})$$

$$\xi \equiv \sqrt{2eB} \left(x - \frac{p_y}{eB} \right) = x \sqrt{eB} - b$$

Zero Mode

$$E = 0$$

$$\Psi_{0,b}(\mathbf{r}) = \sqrt{\frac{eB}{2\pi}} \begin{pmatrix} 1 \\ 0 \end{pmatrix} \frac{1}{\sqrt[4]{2\pi}} \exp\{iyp_y - \frac{1}{4} \xi^2\}$$

Orthonormality relations

$$\int d^2r \Psi_{0,b'}^\dagger(\mathbf{r}) \Psi_{0,b}(\mathbf{r}) = \delta(b - b')$$

Uniform probability density for the completely filled Landau band

$$\int_{-\infty}^{\infty} db \Psi_{0,b}^\dagger(\mathbf{r}) \Psi_{0,b}(\mathbf{r}) = \frac{eB}{2\pi} = \frac{eB}{hc}$$

Landau degeneracy per unit area

Symmetric Normal Modes

$$E = \pm E_n = \pm \sqrt{2neB}$$

$$\Psi_{n,b}^{(\pm)}(t, \mathbf{r}) = \sqrt{\frac{eB}{2\pi}} \exp\{\mp iE_n t + iyp_y\}$$

$$\times (2\pi)^{-1/4} \begin{pmatrix} \phi_n(\xi) \cos \theta_n^{(\pm)} \\ \phi_{n-1}(\xi) \sin \theta_n^{(\pm)} \end{pmatrix}$$

$$\phi_n(\xi) \equiv \left(2^n n! \sqrt{2\pi}\right)^{-1/2} e^{-\xi^2/4} H_n(\xi/\sqrt{2})$$

Hermite functions

$$\tan \theta_n^{(\pm)} = \mp E_n \quad n \in \mathbf{N}$$

Orthonormality and closure relations

$$\int d^2r \bar{\Psi}_{n',b'}^{(\pm)}(t, \mathbf{r}) \gamma^0 \Psi_{n,b}^{(\pm)}(t, \mathbf{r}) = \delta_{n,n'} \delta(b-b')$$

$$\int_{-\infty}^{\infty} db \bar{\Psi}_{n',b}^{(\pm)}(t, \mathbf{r}) \gamma^0 \Psi_{n,b}^{(\pm)}(t, \mathbf{r}) = \frac{eB}{2\pi} \delta_{n,n'}$$

$$\gamma^0 = \sigma_3 \quad \bar{\Psi} \equiv \Psi^\dagger \gamma^0$$

Effective Action at $T \neq 0 \neq \mu$

Turn to Euclidean space with metric $\bar{g}_{\mu\nu} = (+, +, +)$

$$\bar{\gamma}_j = -i\gamma^j \quad j = 1, 2 \quad \bar{\gamma}_3 = \gamma^0$$

$$\bar{\gamma}_\mu = \sigma_\mu \quad \mu = 1, 2, 3 \quad \{\bar{\gamma}_\mu, \bar{\gamma}_\nu\} = 2\delta_{\mu\nu} \mathbf{I}$$

$$ix_0 = x_3 \quad \bar{x}_\mu = (x_1, x_2, x_3) = (\mathbf{r}, \tau) = (x, y, \tau)$$

$$A_0 = iA_3 \quad \bar{A}_\mu = (\mathbf{A}, A_3) = (0, Bx, -iv/e)$$

$$0 < \tau < \beta = T^{-1} \quad v = \mu + i\gamma \in \mathbf{C}$$

To describe graphene use massless Euclidean Dirac operator

$$\mathcal{D}_E = \sigma_1 (-i\partial_x) + \sigma_2 (-i\partial_y - eBx) + \sigma_3 (-i\partial_\tau + iv)$$

Euclidean Effective Action: Grand Potential in Statistical Mechanics

$$\beta\Omega = \ln \mathcal{Z} = \ln \det [\beta(i\mathcal{D} + e\mathcal{A})_{AP}]$$

Anti-Periodic boundary conditions to ensure Fermi-Dirac statistics

Zeta-Function Regularisation

$$\ln \mathcal{Z} = - \left. \frac{d}{ds} \text{Tr} (\beta\mathcal{D}_E)^{-s} \right|_{s=0}$$

Spectral resolution of the Euclidean Dirac operator
with generalized L^2 –Integrability and
Anti-Periodicity : Matsubara angular frequencies

$$\omega_\ell = (2\ell + 1) \pi / \beta \quad \ell \in \mathbf{Z}$$

Ansatz for the eigenfunctions

$$\Psi(x, y, \tau) = \not\int_{\ell, p} \exp\{i(\tau \omega_\ell + p y)\} \frac{\psi_{\ell, p}(x)}{\sqrt{2\pi\beta}}$$

$$\not\int_{\ell, p} \equiv \sum_{\ell=-\infty}^{\infty} \int_{-\infty}^{\infty} dp$$

$$(\not{D}_E - \lambda) \Psi_\lambda(x, y, \tau) = 0$$

Spectrum has two parts : **Asymmetric vs Symmetric**

- **Asymmetric Spectrum** $\lambda = \lambda_\ell$ **Chiral Modes**

$$\lambda_\ell = \omega_\ell - \gamma + i\mu \in \mathbf{C} \quad \forall \ell \in \mathbf{Z}$$

$$\Psi_{\ell,p,0}(\tau, \mathbf{r}) = \sqrt[4]{\frac{eB}{\pi}} \exp\left\{-\frac{1}{2}eB(x - p/eB)^2\right\} \\ \times \exp\{i\tau\omega_\ell + ipy\} (2\pi\beta)^{-1/2} \begin{pmatrix} 1 \\ 0 \end{pmatrix}$$

Normalization is given by

$$\int_0^\beta d\tau \int d^2r \Psi_{\ell,p,0}^\dagger(\mathbf{r}, \tau) \Psi_{j,q,0}(\mathbf{r}, \tau) = \delta_{\ell j} \delta(p - q)$$

Degeneracy *per* unit area just like in the zero temperature case

$$\int_0^\beta d\tau \int_{-\infty}^{\infty} dp \left| \Psi_{\ell,p,0}(\mathbf{r}, \tau) \right|^2 = \frac{eB}{2\pi}$$

- Symmetric Spectrum $\lambda = \pm \lambda_{\ell, n}$ Normal Modes

$$\lambda_{\ell, n} = \sqrt{\lambda_{\ell}^2 + 2neB} \quad n \in \mathbf{N} \quad l \in \mathbf{Z}$$

Normalized eigenstates are given by

$$\Psi_{\ell, p, n}^{\pm}(\mathbf{r}, \tau) = \sqrt[4]{2eB} \exp\{i\tau\omega_{\ell} + ipy\} (4\pi\beta)^{-\frac{1}{2}}$$

$$\times \left(1 + |\kappa_{\ell, n}^{\pm}|^2\right)^{-\frac{1}{2}} \begin{pmatrix} \pm i\phi_n(\xi) \\ \kappa_{\ell, n}^{\pm} \phi_{n-1}(\xi) \end{pmatrix}$$

$$\kappa_{\ell, n}^{\pm} = (2eB)^{-\frac{1}{2}} (\lambda_{\ell, n} \mp \lambda_{\ell})$$

Degeneracy

$$\int_0^{\beta} d\tau \int_{-\infty}^{\infty} dp \left| \Psi_{\ell, p, n}^{\pm}(\mathbf{r}, \tau) \right|^2 = \frac{eB}{2\pi}$$

Euclidean Effective Action for a unit cell of area \mathcal{A}

$$\begin{aligned}\beta\Omega(a, b) &= - \left. \frac{d}{ds} \text{Tr} (\beta \mathcal{D}_E)^{-s} \right|_{s=0} \\ &= \mathcal{A} \frac{eB}{hc} [A(a) + S(a, b)]\end{aligned}$$

Dimensionless reduced variables

$$a \equiv \frac{\beta v}{2\pi} \in \mathbf{C} \qquad b \equiv \frac{1}{2} \beta \sqrt{2eB} \in \mathbf{R}$$

- The contribution to Ω from **Symmetric Spectrum** is ζ -regularisation prescription independent viz.

$$\begin{aligned}S(a, b) - 2b \zeta \left(-\frac{1}{2}\right) &= \\ \sum_{n=1}^{\infty} \ln \left\{ (1 + e^{2\pi a - \beta E_n}) (1 + e^{-2\pi a - \beta E_n}) \right\}\end{aligned}$$

- The contribution to Ω from **Asymmetric Spectrum**

$$A(a) = - \left(\frac{d}{ds} \zeta_A (s, a) \right) \Big|_{s=0}$$

$$\zeta_A (s, a) = \sum_{\ell=0}^{\infty} \left[\frac{1}{(\ell + q_+)^s} + \frac{e^{\mp i\pi s}}{(\ell + q_-)^s} \right]$$

$$q_{\pm} \equiv \frac{1}{2} \pm \frac{i\beta}{2\pi} (\mu + i\gamma) \quad |\beta\gamma| < \pi$$

The right hand side involves the sum of two series representations of Hurwitz Zeta functions $\zeta(s, q)$ which are well defined if and only if

$$\Re s > 1 \quad \beta\gamma \neq \pm \pi (2n - 1) \quad (n \in \mathbf{N})$$

Calculation yields

$$A(a) = \ln \left(e^{\pi a} + e^{-\pi a} \right) \mp \pi a$$

The ζ -regularization prescription $e^{\mp i\pi s}$ gives rise to a **phase of the determinant**

A relation can be established between **phase prescription** \vee **sign of chemical potential** driving to a discrete 2-valued parameter κ

1. **Usual** prescription

$$\kappa = -1$$

$$A(a) - \ln 2 \cosh \pi a = \begin{cases} -\pi a, & \text{for } \mu > 0 \\ +\pi a, & \text{for } \mu < 0 \end{cases}$$

2. **Unusual** prescription

$$\kappa = +1$$

$$A(a) - \ln 2 \cosh \pi a = \begin{cases} +\pi a, & \text{for } \mu > 0 \\ -\pi a, & \text{for } \mu < 0 \end{cases}$$

Result for a real chemical potential $[a = \beta\mu/2\pi, \gamma = 0]$

C.G. Beneventano, P. Giacconi, E.M. Santangelo, R.S. (2007)

$$\frac{\beta\Omega}{\mathcal{A}} = \frac{eB}{2\pi} \left\{ \frac{1}{2} \kappa \beta |\mu| + \ln 2 \cosh \frac{1}{2} \beta\mu + 2b \zeta \left(-\frac{1}{2}\right) \right. \\ \left. + \sum_{n=1}^{\infty} \ln \left[\left(1 + e^{2\pi a - \beta E_n}\right) \left(1 + e^{-2\pi a - \beta E_n}\right) \right] \right\}$$

Average fermion density $\mathcal{A} \beta \bar{N} = (\partial\Omega/\partial\mu)_\beta$

$$\bar{N}_\kappa(\beta, \mu) = \frac{eB}{4\pi} \left\{ \tanh \frac{1}{2} \beta\mu + \kappa \operatorname{sgn}(\mu) \right. \\ \left. + \sum_{n=1}^{\infty} \left[\frac{e^{2\pi a - \beta E_n}}{1 + e^{2\pi a - \beta E_n}} - \frac{e^{-2\pi a - \beta E_n}}{1 + e^{-2\pi a - \beta E_n}} \right] \right\}$$

Average charge density at finite temperature and fermion density

$$\bar{J}_0(\beta, \mu) = -e \bar{N}_\kappa(\beta, \mu)$$

Hall Current Density

At $T \downarrow 0$ all the Landau bands completely filled up to the n -th

$$n < \mu^2/2eB < n + 1$$

1. Without electric static Hall field $E_x = E_y = 0$

$$\lim_{\beta \rightarrow \infty} \bar{J}_0(\beta, \mu) = -\frac{e^2 B}{h} \left[n + \frac{1}{2}(1 + \kappa) \right] \text{sgn}(\mu)$$

Expedient : A Lorentz Boost generates the Electric Field

$$E'_y = 0 \quad E'_x/B' = \tanh \eta_y \sim v_y/c$$

2. With the electric static Hall field $\bar{J}'_x(\beta, \mu) = 0$

$$\bar{J}'_y(\infty, \mu) \sim -\frac{e^2 E'_x}{h} \left[n + \frac{1}{2}(1 + \kappa) \right] \text{sgn}(\mu)$$

Hall conductivity ($\leq n$) for τ with two flavours (spin)

$$\sigma_{xy}^{(n)} = -\frac{2e^2}{h} \left[n + \frac{1}{2}(1 + \kappa) \right] \text{sgn}(\mu)$$

What about the Graphene Reducible Representation $\tau \oplus \tilde{\tau}$?

Our result in plot

Opposite Phases (measured in mono-layer)

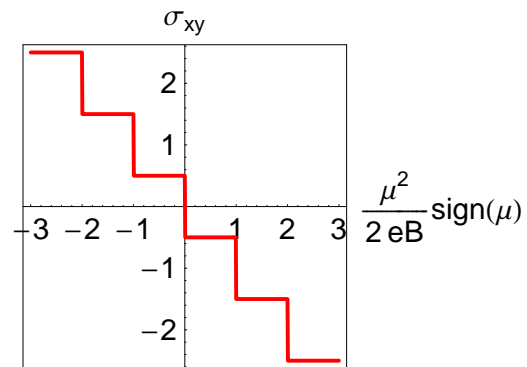

Both Unusual Phases (measured in bi-layer)

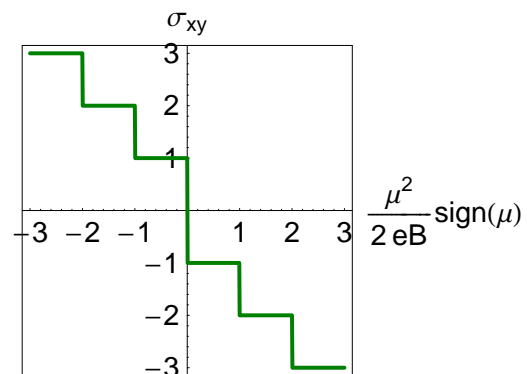

Both Usual Phases (measured in multi-layer)

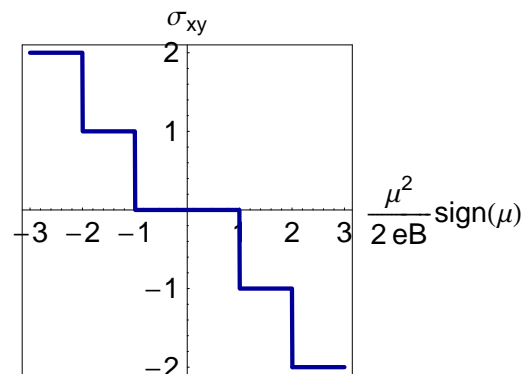

Large Gauge Transformations

Grand Potential per unit cell
with a complex chemical potential

$$2\pi a = \beta\mu + i\beta\gamma \quad |\beta\gamma| < \pi$$

$$\frac{\beta\Omega}{\mathcal{A}} = \frac{eB}{2\pi} [A(a) + S(a, b)]$$

Invariance under Large Gauge Transformations

$$\Psi(\mathbf{r}, \tau) \longrightarrow \Psi(\mathbf{r}, \tau) \exp \{i\tau (2\pi j/\beta)\}$$

leave untouched AntiPeriodic Boundary Conditions

The Grand Potential is Invariant under LGTs

$$\Omega(\beta, v) = \Omega(\beta, v + 2\pi i j/\beta) \quad (\forall j \in \mathbf{Z})$$

Rotation of the Spinor Zero Modes

Invariance under Large Gauge Transformations is respected by ζ -regularization for both $\kappa = \pm 1$

It must be so for topological reasons : LGTs do retain AP Boundary Conditions and Fermi–Dirac Statistics

Chiral Modes from the Asymmetric Spectrum are eigenstates of σ_3 with eigenvalue $+1$ so we have

$$\Psi_{\ell,p,0}(\tau, \mathbf{r}) \rightarrow \exp \left\{ \frac{1}{2} \sigma_3 (2\gamma) \tau \right\} \Psi_{\ell,p,0}(\tau, \mathbf{r})$$

As $\tau = \beta$ spinors are rotated by $2\gamma\beta$: it follows that

$\gamma\beta = 2\pi$ is a 4π -rotation around the magnetic field

Rotation Invariance under a 4π -Angle of the Chiral Modes just corresponds to the Large Gauge Transformations Invariance of the Grand Potential

Chern–Simons Action

Zero Temperature Limit $T \downarrow 0$ or $\beta \rightarrow \infty$ of the
Chiral Modes contribution

$$\lim_{\beta \rightarrow \infty} \Omega_{ZM} = \mathcal{A} \frac{eB}{4\pi} (\kappa + 1) (\mu + i\gamma) \operatorname{sgn}(\mu)$$

1. for $\kappa = -1$ we get $\Omega_{ZM}(T \downarrow 0) = 0$
2. for $\kappa = +1$ we find instead

$$\Omega_{ZM}(T \downarrow 0) = \mathcal{A} \frac{eB}{2\pi} (\mu + i\gamma) \operatorname{sgn}(\mu)$$

remember $ieA_3 = \mu + i\gamma$ and $F_{12} = B$ so that

$$\mathcal{A}^{-1} \Omega_{ZM} \xrightarrow{T \downarrow 0} \frac{e^2 B}{2\pi} iA_3 \operatorname{sgn}(\mu) = \pm \alpha \varepsilon^{\mu\nu\rho} F_{\mu\nu} A_\rho$$

Abelian Chern–Simons Lagrangian Density

Electric field at $T = 0 = \mu$

Exact solution of the Dirac equation : choose

$$\gamma^0 = \sigma_1 \quad \gamma^1 = i\sigma_2 \quad \gamma^2 = i\sigma_3$$

Electric field $\mathbf{E} = (E, 0)$ and **Nikishov gauge** choice

$$A_0 = 0 \quad A_x = Et \quad A_y = 0 \quad (E > 0)$$

Time Dependent Massless Dirac Equation

$$[i\partial_t \sigma_1 + (i\partial_x + eEt) i\sigma_2 - \partial_y \sigma_3] \Psi = 0$$

$$\Psi(t, x, y) = \frac{1}{2\pi} \int_{-\infty}^{\infty} dp \int_{-\infty}^{\infty} dk e^{ipx+iky} \tilde{\Psi}(t, p, k)$$

$$p = p_x \quad k = p_y$$

$$\xi \equiv (eEt - p_x) / \sqrt{eE} \quad \lambda \equiv p_y^2 / eE$$

If we write

$$\tilde{\Psi}(t, p, k) = \begin{pmatrix} \tilde{\varphi}(t, p, k) \\ \tilde{\chi}(t, p, k) \end{pmatrix}$$

we obtain the coupled differential equations

$$ik \tilde{\varphi} = \sqrt{eE} (id_{\xi} + \xi) \tilde{\chi}$$

$$\sqrt{eE} (-id_{\xi} + \xi) \tilde{\varphi} = ik \tilde{\chi}$$

Then we can write

$$i \tilde{\chi} = (-id_{\xi} + \xi) \tilde{\varphi} / \sqrt{\lambda} \quad (\lambda \neq 0)$$

$$(d_{\xi}^2 + \xi^2 + \lambda + i) \tilde{\varphi} = 0$$

$$(id_{\xi} + \xi) \tilde{\chi} = 0 = (-id_{\xi} + \xi) \tilde{\varphi} \quad (\lambda = 0)$$

the general solutions can be expressed in terms of two different sets of linearly independent solutions involving the **Parabolic Cylinder Functions** $D_q(z)$

The Outgoing Spinor Set

$$u_{\mathbf{p}+}(t, \mathbf{r}) = \sqrt{\frac{eE}{2\pi}} \exp \left\{ i \mathbf{p} \cdot \mathbf{r} - \frac{1}{8} \pi \lambda \right\} \\ \times \begin{pmatrix} D_{-i\lambda/2}(z_+) \\ \frac{1}{2} (i-1) \sqrt{\lambda} D_{-i\lambda/2-1}(z_+) \end{pmatrix}$$

$$v_{\mathbf{p}+}(t, \mathbf{r}) = \sqrt{\frac{eE}{2\pi}} \exp \left\{ i \mathbf{p} \cdot \mathbf{r} - \frac{1}{8} \pi \lambda \right\} \\ \times \begin{pmatrix} \frac{1}{2} (1+i) \sqrt{\lambda} D_{i\lambda/2-1}(z_-) \\ D_{i\lambda/2}(z_-) \end{pmatrix}$$

$$z_{\pm} = (1 \pm i) \xi = (1 \pm i) [\omega_E t - \text{sgn}(p_x) \sqrt{\eta}]$$

$$\omega_E = \sqrt{eE} \quad \eta \equiv \frac{p_x^2}{eE} \quad \lambda \equiv \frac{p_y^2}{eE}$$

The Incoming Spinor Set

$$u_{\mathbf{p}-}(t, \mathbf{r}) = \sqrt{\frac{eE}{2\pi}} \exp\left\{i\mathbf{p} \cdot \mathbf{r} - \frac{1}{8}\pi\lambda\right\} \\ \times \begin{pmatrix} -\frac{1}{2}(1+i)\sqrt{\lambda} D_{i\lambda/2-1}(-z_-) \\ D_{i\lambda/2}(-z_-) \end{pmatrix}$$

$$v_{\mathbf{p}-}(t, \mathbf{r}) = \sqrt{\frac{eE}{2\pi}} \exp\left\{i\mathbf{p} \cdot \mathbf{r} - \frac{1}{8}\pi\lambda\right\} \\ \times \begin{pmatrix} D_{-i\lambda/2}(-z_+) \\ \frac{1}{2}(1-i)\sqrt{\lambda} D_{-i\lambda/2-1}(-z_+) \end{pmatrix}$$

$$D_{-i\lambda/2}(z_{\pm}) = \frac{1}{\sqrt{\pi}} 2^{-i\lambda/2+1/2} e^{-\pi\lambda/4} e^{i\xi^2/2} \\ \times \int_{-\infty}^{\infty} x^{-i\lambda/2} e^{-2x^2 \pm 2ix(1+i)\xi} dx$$

$$\lambda > 0 \quad \xi \in \mathbf{R} \quad \arg x^{-i\lambda/2} = \lambda/2 \quad \text{for } x < 0$$

Normalisation is fixed in such a way to obtain
Uniform Probability Density on the whole Sample
 this leads to the **Electric Degeneracy Factor**

$$u_{\mathbf{p}\pm}^\dagger(t, \mathbf{r}) u_{\mathbf{p}\pm}(t, \mathbf{r}) = \frac{eE}{2\pi} = v_{\mathbf{p}\pm}^\dagger(t, \mathbf{r}) v_{\mathbf{p}\pm}(t, \mathbf{r})$$

as well as to **Orthonormality and Closure Relations**

$$\int d\mathbf{r} u_{\mathbf{q}\pm}^\dagger(t, \mathbf{r}) u_{\mathbf{p}\pm}(t, \mathbf{r}) = \frac{eE}{2\pi} \delta(\mathbf{p} - \mathbf{q})$$

$$\int d\mathbf{r} v_{\mathbf{q}\pm}^\dagger(t, \mathbf{r}) v_{\mathbf{p}\pm}(t, \mathbf{r}) = \frac{eE}{2\pi} \delta(\mathbf{p} - \mathbf{q})$$

$$\int d\mathbf{r} v_{\mathbf{q}\pm}^\dagger(t, \mathbf{r}) u_{\mathbf{p}\pm}(t, \mathbf{r}) = 0$$

$$\int d\mathbf{p} u_{\mathbf{p}\pm}^\dagger(t, \mathbf{r}') u_{\mathbf{p}\pm}(t, \mathbf{r}) = \frac{eE}{2\pi} \delta(\mathbf{r} - \mathbf{r}')$$

$$\int d\mathbf{p} v_{\mathbf{p}\pm}^\dagger(t, \mathbf{r}') v_{\mathbf{p}\pm}(t, \mathbf{r}) = \frac{eE}{2\pi} \delta(\mathbf{r} - \mathbf{r}')$$

$$\int d\mathbf{p} v_{\mathbf{p}\pm}^\dagger(t, \mathbf{r}') u_{\mathbf{p}\pm}(t, \mathbf{r}) = 0$$

Physical Meaning of the Spinor Solutions

Eigenstates of Momentum and Charge

To Understand the Physical Meaning of the Spinor Wave Functions it is Necessary to Discuss All the Asymptotic Regimes

1. Weak Field \cup High Transverse Momentum

$$\lambda \gg 1 \quad \forall \eta \in \mathbf{R}$$

2. Strong Field \cup Low Momenta

$$\lambda \ll 1 \quad \eta \ll 1$$

3. Low Transverse \cup High Longitudinal Momenta

$$\lambda \ll 1 \quad \eta \gg 1 \quad \Leftrightarrow \quad p_y^2 \ll eE \ll p_x^2$$

1. Weak Field \cup High Transverse Momentum

$$\lambda \gg 1 \quad \forall \eta \in \mathbf{R}$$

- Overall exponential damping factor

$$\exp\left\{-\frac{1}{8} \pi \lambda\right\}$$

which rapidly drives to zero the spinor sets

- In the limit of a null electric field

$$E \rightarrow 0$$

all spinor wave functions do vanish

- A continuous matching with the free field plane waves spinor solutions never occurs
- The spinor solutions

$$u_{\mathbf{p}\pm}(t, \mathbf{r}) \quad v_{\mathbf{p}\pm}(t, \mathbf{r})$$

are truly non-perturbative $\forall \mathbf{p} \in \mathbf{R}^2$

2. Strong Field \cup Low Momenta

$$\lambda \ll 1 \quad \eta \ll 1$$

Stationary Spinor Solutions for $p_x^2 + p_y^2 \ll eE$

$$u'_{\mathbf{p},+}(\mathbf{r}) \sim \sqrt{\frac{eE}{2\pi}} \exp\{i\mathbf{p} \cdot \mathbf{r}\} \begin{pmatrix} 1 \\ 0 \end{pmatrix}$$

3. Low Transverse \cup High Longitudinal Momenta

$$\lambda \ll 1 \quad \eta \gg 1 \quad \Leftrightarrow \quad p_y^2 \ll eE \ll p_x^2$$

Leading Asymptotic Behaviour for $t \rightarrow +\infty$

$$u_{\mathbf{p}+}(t, \mathbf{r}) \sim e^{i\mathbf{p} \cdot \mathbf{r} - \frac{1}{2} i \xi^2(t)} \begin{pmatrix} 1 \\ 0 \end{pmatrix} \sqrt{\frac{eE}{2\pi}}$$

Positive Frequency $\frac{1}{2} \xi^2(t)$ describes outgoing quasi-particle of momentum \mathbf{p} and charge $-e$

Quantized Spinor Field

$$\Psi(t, \mathbf{r}) = \int d\mathbf{p} \left[a_{\mathbf{p}\pm} u_{\mathbf{p}\pm}(t, \mathbf{r}) + b_{\mathbf{p}\pm}^\dagger v_{\mathbf{p}\pm}(t, \mathbf{r}) \right]$$

Canonical Anticommutation Relations

$$\{a_{\mathbf{p}\pm}, a_{\mathbf{q}\pm}^\dagger\} = \delta(\mathbf{p} - \mathbf{q}) \quad \text{et cetera}$$

Current Density Operators

$$J_x(t, \mathbf{r}) = (-e) \int d\mathbf{r} : \Psi^\dagger(t, \mathbf{r}) \sigma_3 \Psi(t, \mathbf{r}) :$$

$$J_y(t, \mathbf{r}) = e \int d\mathbf{r} : \Psi^\dagger(t, \mathbf{r}) \sigma_2 \Psi(t, \mathbf{r}) :$$

1-quasiparticle (electron) state $|\mathbf{k}\pm\rangle = a_{\mathbf{k}\pm}^\dagger |0\rangle$

$$\langle J_x(t, \mathbf{r}) \rangle_{\mathbf{k}\pm} \sim \frac{4e^2}{h} E$$

$$\sigma_{\min} = \frac{4e^2}{h}$$

$$\langle J_y(t, \mathbf{r}) \rangle_{\mathbf{k}\pm} \sim 0 \quad \sigma_{xy} = 0$$

for All the Dynamical Regimes

Our result in plot

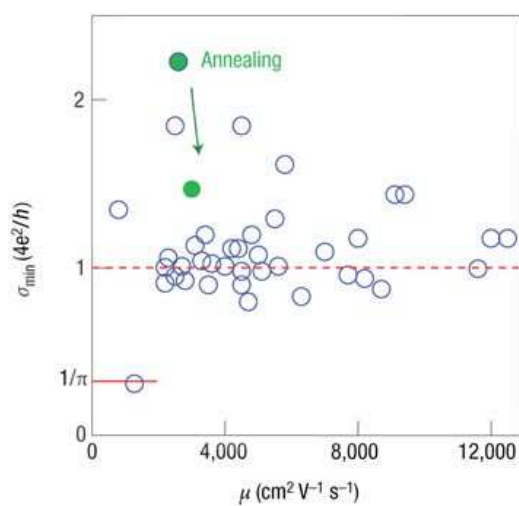

Graphene Minimum Quantum Conductivity

List of wrong theoretical predictions
using the Kubo formula and known as
The Mystery of the Missing π

A.W.W. Ludwig, M.P.A. Fisher, R. Shankar, and G. Grinstein, *Phys. Rev. B* **50**, 7526 (1994); K. Ziegler, *Phys. Rev. B* **55**, 10661 (1997); *Phys. Rev. Lett.* **80**, 3113 (1998); V.P. Gusynin and S.G. Sharapov, *Phys. Rev. B* **66**, 045108 (2002); *Phys. Rev. Lett.* **95**, 146801 (2005); M.I. Katsnelson, *Eur. Phys. J. B* **51**, 157 (2006); N.M.R. Peres, F. Guinea, and A.H. Castro Neto, *Phys. Rev. B* **73**, 125411 (2006); J. Tworzydło, B. Trauzettel, M. Titov, A. Rycerz, and C. Beenakker, *Phys. Rev. Lett.* **96**, 246802 (2006); P.M. Ostrovsky, I.V. Gornyi, A.D. Mirlin, *Phys. Rev. B* **74**, 235443 (2006); S. Ryu, C. Mudry, A. Furusaki, A.W.W. Ludwig, cond-mat/0610598; L.A. Falkovsky and A.A. Varlamov, cond-mat/0606800; K. Ziegler, *Phys. Rev. Lett.* **97**, 266802 (2006); *Phys. Rev. B* **73**, 245411 (2006); J. Cserti, *Phys. Rev. B* **75**, 033405 (2007)

Effective Action and Pairs

To fix completely all normalisations and degeneracy
it is mandatory to start from
the Euclidean formulation at finite β

$$\bar{\gamma}_1 = \sigma_1 \quad \bar{\gamma}_2 = \sigma_3 \quad \bar{\gamma}_3 = \sigma_2$$

$$ix_0 = \tau \in [0, \beta] \quad x_\mu = (x, y, \tau)$$

$$e\bar{A}_\mu = (0, 0, e\mathcal{E}x + iv) \quad A_0 = i\bar{A}_3$$

$$\text{Euclidean Dirac Operator} \quad \mathcal{E} \equiv -iE$$

$$\mathcal{D}_E = (i\partial_\tau - e\mathcal{E}x - iv) \sigma_2 + i\partial_x \sigma_1 + i\partial_y \sigma_3$$

Fourier Decomposition of the Wave Function

$$\Psi(x, y, \tau) = \sum_{\ell, k} \frac{\tilde{\Psi}_\ell(x, k)}{\sqrt{2\pi\beta}} \exp\{i\tau\omega_\ell + ik y\}$$

$$\omega_\ell = \frac{\pi}{\beta} (2\ell + 1) \quad \text{Matsubara frequencies}$$

Spectrum and Degeneracy

$$\lambda_{k,0} = k \quad \lambda_{k,n} = \pm \sqrt{k^2 + 2e\mathcal{E}n}$$

$$n = 1, \dots, \infty \quad k \in \mathbf{R} \quad (\forall \ell \in \mathbf{Z})$$

$$\sum_{\ell=-\infty}^{\infty} \Psi_{n,k,\ell}^\dagger(x, y, \tau) \Psi_{n,k,\ell}(x, y, \tau) = \frac{e\mathcal{E}}{4\pi^2}$$

Euclidean Effective Action (Grand Potential)

$$\left. \frac{d}{ds} \text{Tr} (\beta \mathcal{D}_{\mathbf{E}})^{-s} \right|_{s=0} = \beta \Omega$$

$$\Omega = \mathcal{A} \mathcal{L}_{\text{eff}}^{\mathbf{E}}(\mathcal{E})$$

$$\mathcal{L}_{\text{eff}}^{\mathbf{E}}(\mathcal{E}) = \frac{\zeta(3/2)}{4\pi^2 \sqrt{2}} (e\mathcal{E})^{3/2} \xrightarrow{\mathcal{E} \rightarrow 0} 0$$

Nota Bene :

The Effective Lagrangian is **non-perturbative** and **does not depend** upon Temperature and Density

Turn back to the Minkowski space-time by means of

$$\mathcal{E} = -iE$$

Effective Lagrangian for f Fermion Species

$$\mathcal{L}_{\text{eff}}^{\text{M}}(E) = f \frac{\zeta(3/2)}{8\pi^2} \left(\frac{eE}{\hbar c} \right)^{3/2} (1 + i)$$

Vacuum Persistence Amplitude

$$\langle 0 \text{ out} | \text{in } 0 \rangle = \exp \left\{ \frac{i}{\hbar} \mathcal{A} c(t_f - t_i) \mathcal{L}_{\text{eff}}^{\text{M}}(E) \right\}$$

Probability of Pair Production (Schwinger Formula)

$$P_{\text{pair}} = 1 - \exp \left\{ -\frac{2c}{\hbar} \mathcal{A} (t_f - t_i) \Im \mathcal{L}_{\text{eff}}^{\text{M}}(E) \right\}$$

O(1) for strong fields $\sim 10^1 \div 10^2$ Tesla

Experimental Device for a Test on Graphene
of the Celebrated 1951 Julian Schwinger Formula ?

Conclusions

- Astonishing agreement between measurement of the Hall conductivity for Graphene Samples and our theoretical predictions based upon the ζ -function Phases of the Dirac Determinant
- Our Solution of the Mystery of the Missing π for the Zero Point Minimum Quantum Conductivity
- Hint for the First Experimental Test of the Famous Schwinger Formula for the Pairs Production
- Graphene : Extraordinary Laboratory for testing the Basic Principles of Quantum Field Theory

